

ARO[®]

DIAPHRAGM PUMPS

3" NON-METALLIC PUMP MODEL





EXP Series 3" Non-Metallic Diaphragm Pump

ARO® EXP Series diaphragm pumps now include new 3" non-metallic models available in polypropylene or PVDF. The NEW 3" non-metallic models are reliable, efficient and offer a lower Total Cost of Ownership that has made ARO® a leading brand in the pumping industry. With flows rates up to 285 gpm (1,079 lpm) our 3" non-metallic models can meet or exceed your application requirements.

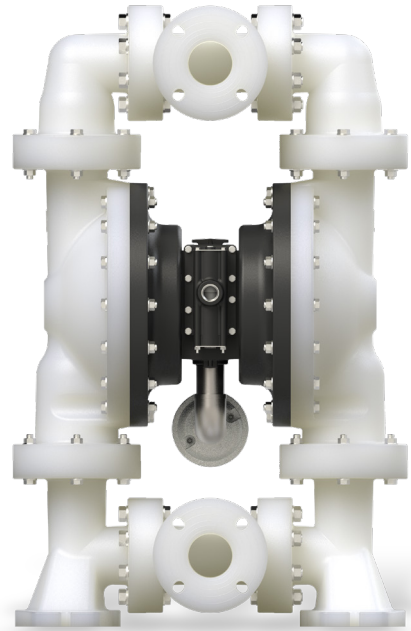

Application expertise in:



Oil and Gas



Industrial



Paint and Coatings



Chemical Processing



Tank Farm / Bulk Transfer



Waste Water / Water Treatment

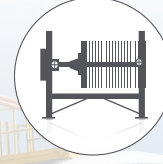

Filter Press



ARO® Diaphragm Pump Technology

All EXP Series pumps are “Process Ready” and enhanced with electronic interface capability providing accurate, electronically controlled operation. Combine our pump with the ARO® Controller or a PLC or PC based system and switch from inaccurate, inefficient manual processes to intelligent fluid management.

ARO® EXP Series diaphragm pumps include all of the benefits of standard air-operating pumps (run dry capability, corrosion resistant center body, rib-less fluid caps, etc.), combined with the rugged reliability of our EXP pump design features.

Features:

- ▶ **EXP Total Cost of Ownership (TCO)**
 Best TCO of all major competitive models tested
- ▶ **EXP Reliability** Lube free patented differential valve both on major air valve and SimulShift (Pilot Valve) provides reliable worry free operation
- ▶ **EXP Serviceability** Modular construction, reduced parts count and simple to use repair kits will minimize repair time and cost
- ▶ **EXP Control & Monitoring - “Process Ready”** Electronic interface capability



assures consistent flow rates and pinpoint control. End of stroke feedback (EOS), leak detection and solenoid actuation
- ▶ **EXP Productivity** Maximized flow rates with minimized pulsation and air consumption = Maximum Performance

1 Year Total Cost of Ownership (TCO)

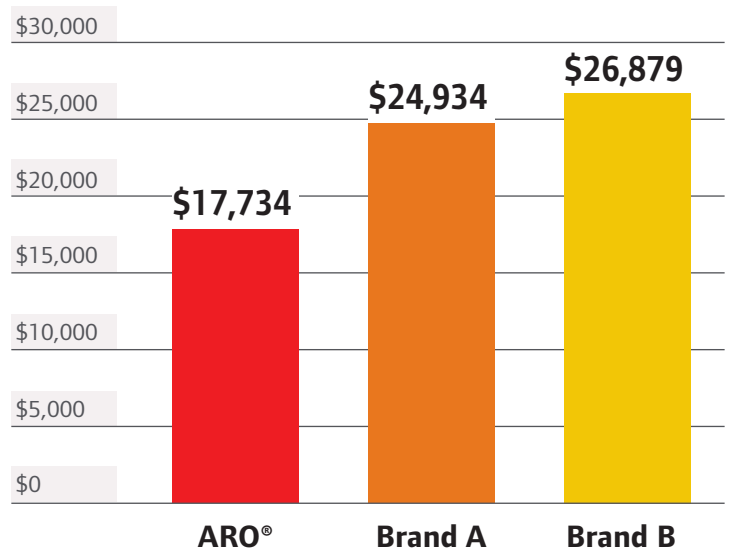

Operating Assumptions

- Pump Operating @ 200 gpm, 10 psi
- 4 hours/day (intermittent)
- 300 days/year
- Industrial electricity rate \$0.109/kWh
- 2.0M cycles between service
- Labor rate \$50/hour @ 3 hrs, 50 minutes per repair

TCO calculations include purchase price, energy cost, service labor, and service kits

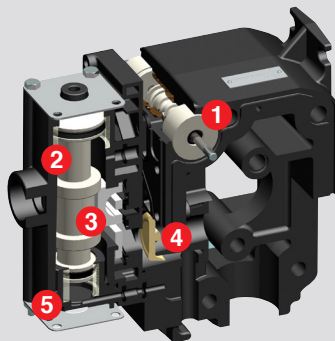

Patented ARO® Air Motor Technology

- 1 SimulShift™ Valve; avoids stall-out – provides faster pump trip-over with more flow.
- 2 Unbalanced™ Major Air Valve; eliminates pump stall-out, even under low air inlet pressures.
- 3 “D” Valve for optimum energy efficiency while avoiding costly air “blow-by” – ceramic construction for long service life.
- 4 Quick Dump™ Checks, eliminates pump ice-up by diverting cold, wet exhaust air away from the major air valve.
- 5 Simplified Major Air Valve Block, is easy to access, simple to service and lube free. Engineered thermoplastic body combines strength with corrosion resistance,

3-Inch Air Operated Diaphragm Pump

Benefits of the NEW ARO® 3" Non-Metallic Pump:

- Efficient transfer leveraging EXP air motor design
- Faster transfer, 55% more flow than ARO® EXP 2" Non-Metallic models
- Flow accuracy with electronic interface

Specifications

Description	
Ratio	1:1
Maximum GPM (LPM):	285 GPM (1079 LPM)
Air Inlet:	3/4-14 NPT
Fluid Inlet / Outlet	3" ANSI (4-hole) or DIN (8-hole) Flange
Max. operating pressure psi (bar):	120 psi (8.3 Bar)
Suspended solids max. dia. in. (mm):	3/8" (9.5mm)
Weight lbs (kg):	Polypropylene 170 lbs (77.11 kg) PVDF 242 lbs (109.77 kg)
Maximum dry suction lift ft (m):	20.5 ft. (6.3m)
Sound Level:	70 PSI 60 Cycles/Min. 85.3 db(A)
Muffler Included:	67389



Ordering

Position	1	2		3	4	5		6	7	8		9	10	11
Example:	PX30	P	-	X	X	S	-	X	X	X	-	A	X	X

Position 1 Model Series	Position 2 Center Section	Position 3 Connections	Position 4 Wetted Parts	Position 5 Hardware	Position 6 Seat Material	Position 7 Ball Material	Position 8 Diaphragm Material	Position 9
PD30 - Standard Pump PE30† - Electronic Interface Accessible Pump	P - Polypropylene	D - 3" ANSI 4-hole flange F - 3" DIN 8-hole flange	K - PVDF P - Polypropylene	S - SS	K - PVDF P - Polypropylene	A - Santoprene® C - Hytrel® G - Buna- N T - PTFE V - Viton®	A - Santoprene® C - Hytrel® G - Buna- N L - Long-Life PTFE T - PTFE/Santoprene®	Revision Level Position 10 & 11 Specialty Code Fluid control options for pump with electronic interface (PE30 model). See complete description below

Ordering Position 10†

Specialty Code 1 (Blank if no Specialty Code)

A - Solenoid 120VAC	O - Standard Valve Block (No Solenoid)
B - Solenoid 12VDC	P - Ported Motor (No major valve provided)
C - Solenoid 240VAC	
D - Solenoid 24VDC	
N - Solenoid with no coil	

Ordering Position 11

Specialty Code 2 (Blank if no Specialty Code)

E - End of stroke feedback + Leak Detection
F - End of stroke feedback
L - Leak Detection
O - No Option

† Call customer service for availability

Hytrel® and Viton® are registered trademarks of the DuPont company. Santoprene® is a registered trademark of Monsanto Company, licensed to Advanced Elastomer Systems, L.P.

3" Non-Metallic Dimensional Data

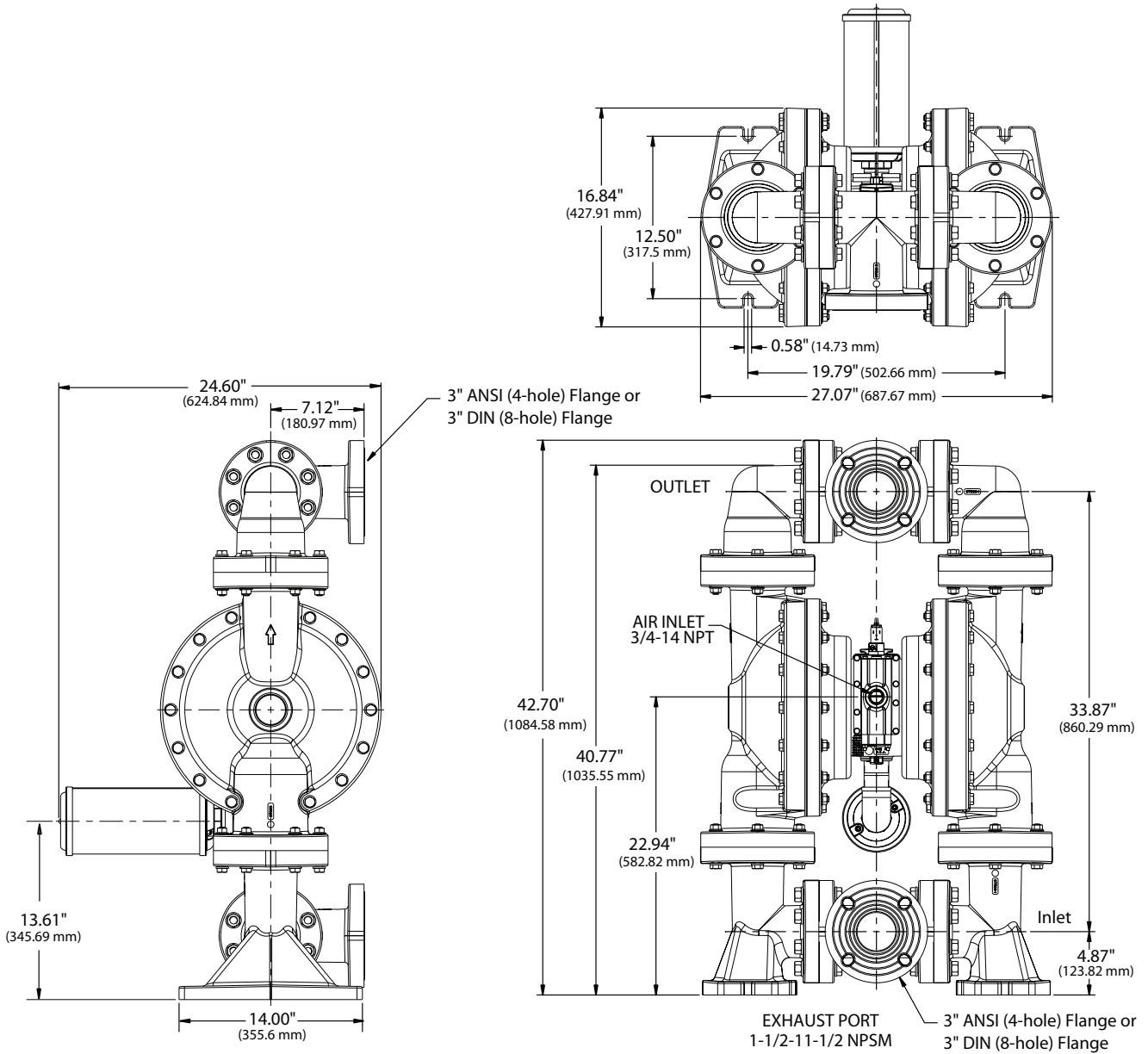

3" Non-Metallic Diaphragm Pumps Accessories

Authentic ARO® Parts include a comprehensive array of diaphragm parts and accessories built exactly by ARO® to compliment your pump. Accessories like diaphragm failure detection kits, end of stroke feedback sensors and genuine ARO® repair kits will keep your pump maintained and running while saving you time and money.



Additional accessories are available in the EXP Series catalog (IRITS-1215-200)

Description	Model Number
Air Line Connection Kit (Piggyback Filter/Regulator with gauge, pipe nipple and 5-foot air hose)	66109
Air motor service repair kit	637369
Major air valve assembly	637374
Fluid section service repair kit	637447-AA 637447-GG 637447-TL 637447-TT
End of stroke sensors -Regular Duty	97121
Leak Detection -Regular Duty	67237

Long-Life PTFE Diaphragm

ARO® Long-Life PTFE Diaphragms are a superior choice over conventional diaphragms.

- Proven 2 time increase in service life over standard PTFE*
- Made with uniquely formulated PTFE that provides greater flex life
- Same great chemical resistance as conventional PTFE
- Seamless replacement for your existing PTFE diaphragms

* As measured by mean time between failure

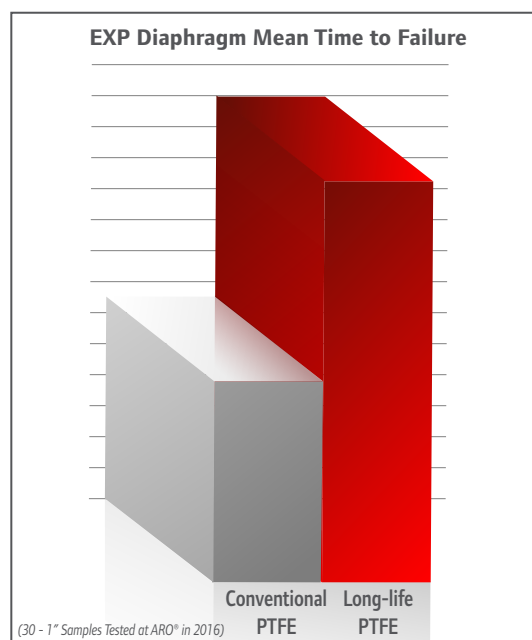
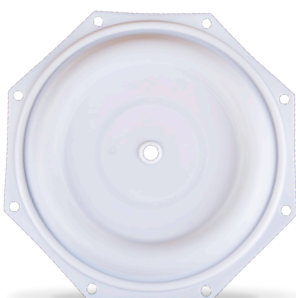

Performance Curves

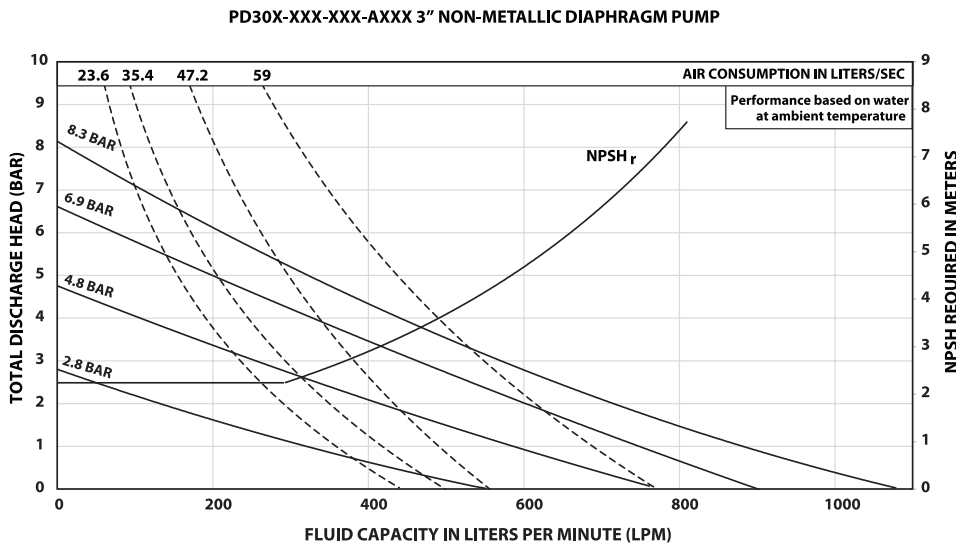
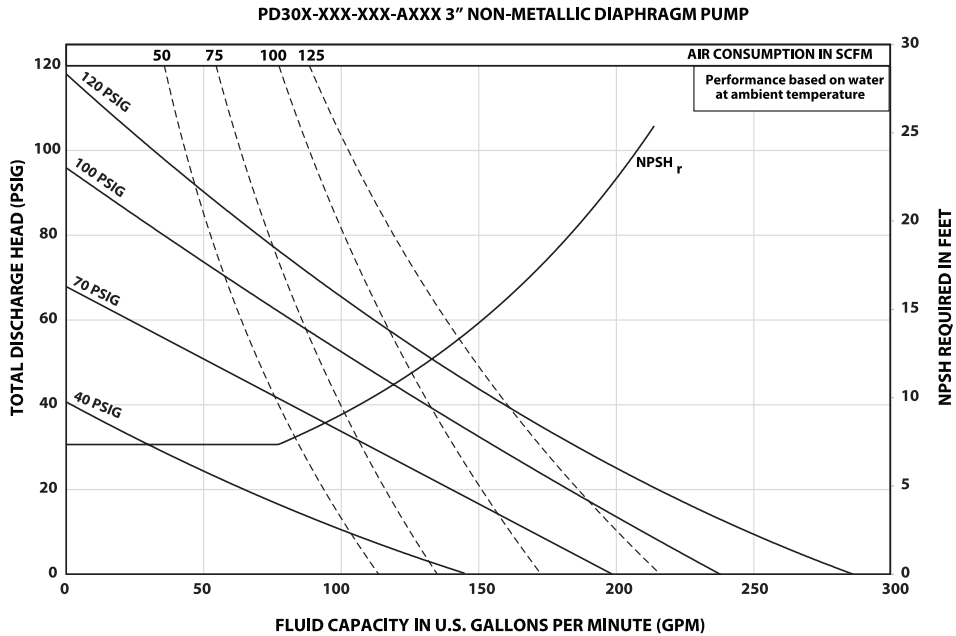

Warranty

All ARO® Pumps are backed up by our 5-year warranty, as a measure of the confidence we place in the quality of these products. A confidence that you can share.

Ingersoll Rand/ARO® warrants to the original use purchaser of IR/ARO® manufactured pumps that Ingersoll Rand/ARO® will repair or replace, free of charges, including return shipping costs within the Continental United States of America, any such product which under normal use and service proves defective in material or workmanship, within FIVE YEARS from date of shipment.

This warranty does not cover failure of parts or components due to normal wear or damage, which in the judgment of Ingersoll Rand/ARO®, that arises from misuse, abrasion, corrosion, negligence, accident, substitution of non-Ingersoll Rand/ARO® parts, faulty installation or tampering.



Distributed by:

www.AROzone.com

arotechsupport@irco.com

youtube.com/aropumps

(800) 495-0276



About Ingersoll Rand

Ingersoll Rand Inc. (NYSE:IR), driven by an entrepreneurial spirit and ownership mindset, is dedicated to helping make life better for our employees, customers and communities. Customers lean on us for our technology-driven excellence in mission-critical flow creation and industrial solutions across 40+ respected brands where our products and services excel in the most complex and harsh conditions. Our employees develop customers for life through their daily commitment to expertise, productivity and efficiency. For more information, visit www.IRco.com.

We are committed to using environmentally conscious print practices

©2018 Ingersoll Rand
IRITS-0218-019 EN 0519